

Data Sheet

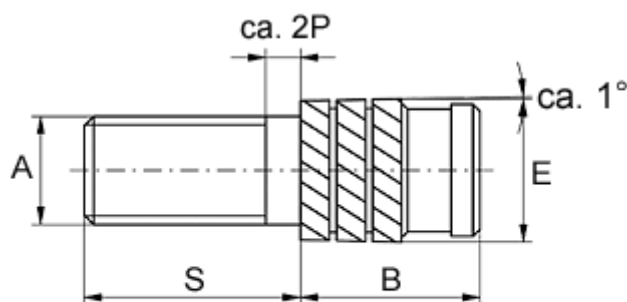

Article number: 12856000050820
Description: KLEE-coil 856 000 050.820
M5 Brass

Measures



Gevindlængde = $S - 2P$
P = stigning

Male thread A	= M5x0,8
Min distance to edge	= 2.5
Mounting length B	= 8.3
Outer diameter E	= 6.60
Pin length S	= 6
Recommended bore diameter	= 6.2
Type	= 856 000 050.820